











Range : 16A-100A
Execution : SPN, DP & TPN
Specification : Conforms to : IS : 13947 - 1 & 3 & IEC : 60947 - 1 & 3



STANDARD REWIRABLE SWITCH FUSE UNIT

Feature

-  Range: 16, 32, 63 and 100 Amps.
-  ISI marked.
-  Available in single pole and neutral, double pole and triple pole and neutral with Rewirable type of HBC type fuse carriers.
-  Tested for utilisation category AC -23A as per IS : 13947 - 1 & 3), IEC : 60947 - 1 & 3.
-  Hard bright tin plated contacts for high conductivity and longer life.
-  Fully shrouded live parts.
-  Rigorous anti-rust conditioning with seven tank process to ensure smooth and lasting paint finish against corrosive atmosphere.
-  Entry holes provided at top and bottom and also at the rear side to facilities cable connections from any side.
-  Terminals suitable for accomodating aluminium/copper conductors.



Dimensions (in mm)

Rating Amps	Voltage V	Execution	Type	A	B	C	D	E	
20	240	SPN/DP	SHF 20 SPN/DP	140	96	56	45	89	
Rating Amps	Voltage V	Execution	Type	A	B	C	D	E	
			REW						
			HBC						
32	240	SPN	SHF 32 SPN	-	230	143	81	84	169.5
32	240	DP	SHF 32 DP	-	230	143	81	84	169.5
32	415	DP	SHF 32 DP	SHF (H) 32 DP	271	173	87	100	203
63	415	DP	SHF 63 DP	SHF (H) 63 DP	355	205	125	123	260
16	415	TPN	SHF 16 TPN	SHF (H) 16 TPN	230	181	81	85	169.5
32	415	TPN	SHF 32 TPN	SHF (H) 32 TPN	270	216	81	120	203
63	415	TPN	SHF 63 TPN	SHF (H) 63 TPN	355	302	125	165	260
100	415	TPN	SHF 100 TPN	SHF (H) 100 TPN	455	336	163	197	370

G. Tolerance ± 1.5

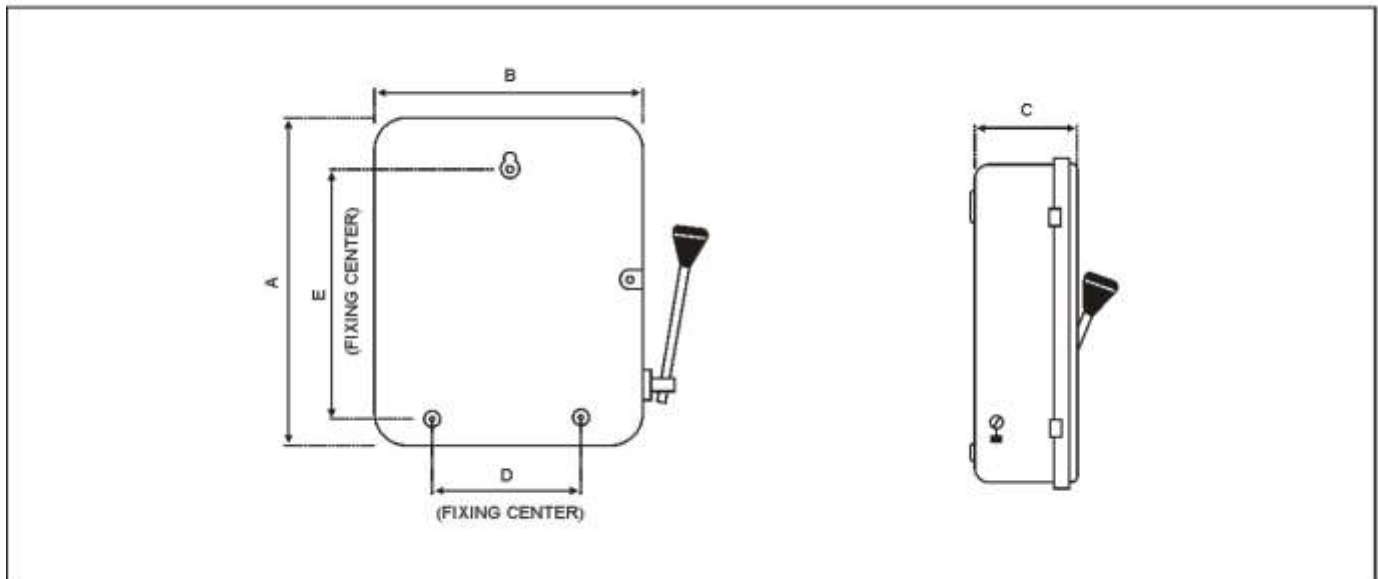
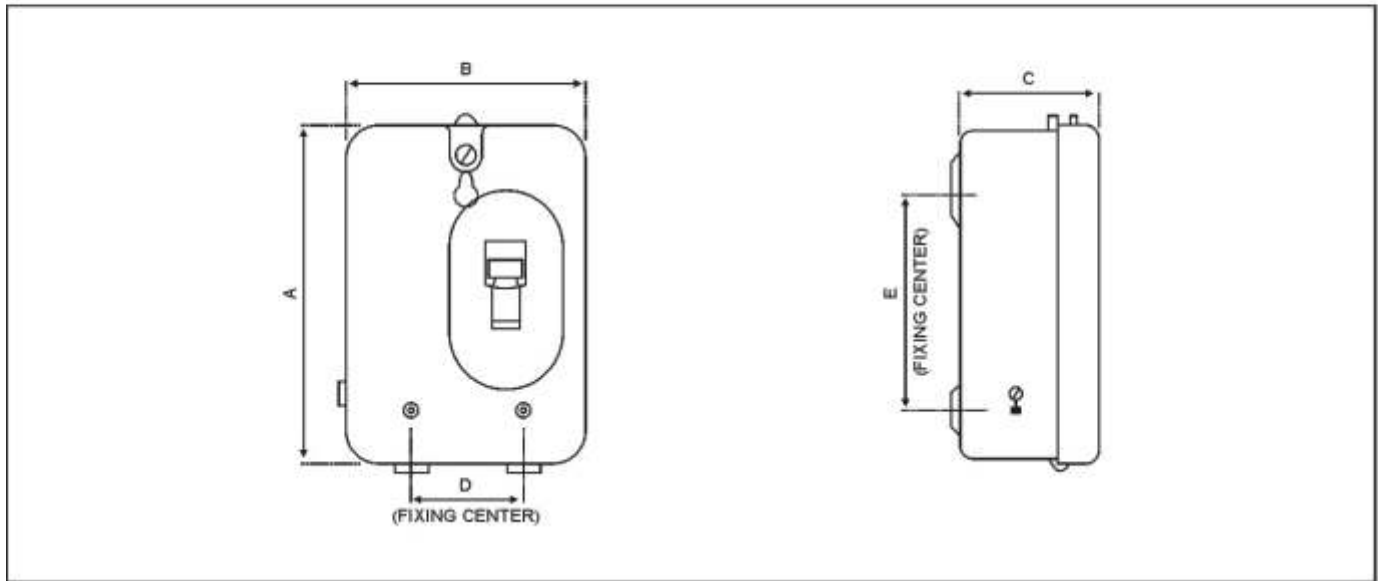

SINGLE POLE & NEUTRAL / DOUBLE POLE

Rating	Cat No.	
	SPN	DP
20	SSRSE2020	-
32	SSRSE2032	SSRDE2032
63	-	SSRDE4063





TRIPLE POLE & NEUTRAL

Rating	Cat No.
16	SSRTE4016
32	SSRTE4032
63	SSRTE4063
100	SSRTE4100



HRC TYPE

Rating	Cat No.	
	DP	TPN
16	-	SSHTE4016
32	SSHDE4032	SSHTE4032
63	SSHDE4063	SSHTE4063
100	-	SSHTE4100

